

NUTS

CONICAL K-LOCK

Steel & Stainless

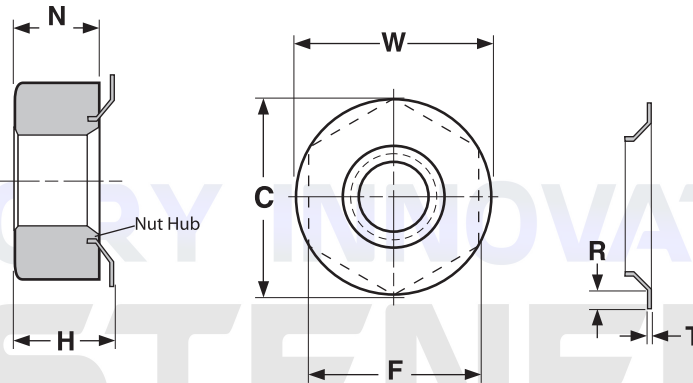

CONICAL K-LOCK NUTS

SAE J238

Nominal Size or Basic Thread Diameter	F		C	N		W		T	H		R		
	Across the Flats		Across Corners	Nut Height		Washer Diameter		Washer Material Thickness	Full Assembly Height		Washer Rim Width		
	Max	Min	Min	Max	Min	Max	Min	Ref	Max	Min	Max	Min	
4	0.1120	.250	.241	.272	.098	.092	.333	.323	.015	.150	.130	.015	.010
6	0.1380	.312	.302	.344	.098	.092	.333	.323	.015	.150	.130	.015	.010
8	0.1640	.344	.332	.378	.130	.117	.380	.370	.020	.195	.170	.015	.010
10	0.1900	.376	.362	.410	.130	.117	.408	.395	.020	.195	.170	.015	.010
1/4	0.2500	.438	.423	.482	.130	.117	.506	.494	.025	.195	.170	.015	.010
• 1/4	0.2500	.438	.423	.482	.130	.117	.750	.730	.057				
5/16	0.3125	.500	.489	.557	.195	.180	.569	.555	.030	.265	.240	.020	.015
3/8	0.3750	.562	.551	.628	.227	.210	.632	.618	.030	.300	.260	.020	.015
• 3/8	0.3750	.562	.551	.628	.337	.310	1.010	.990	.062	.415	.385	-	-

• This size is not governed by the SAE J238 standard.

Description	A hex nut pre-assembled with a free-spinning conical washer. A high tension is maintained in the screw and nut assembly as the nut is tightened against the bearing surface.
Applications / Advantages	Having the washer pre-assembled with the nut shortens installation time. Conical washer assemblies can compensate for joint contraction and expansion and can span slightly oversized holes.
Material	Nuts: Shall be made from a low carbon steel that conforms to the following chemical composition: <i>Carbon:</i> 0.47% max.; <i>Phosphorous:</i> 0.12% max.; <i>Sulfur:</i> 0.15% max. Washers: SAE 1050 - 1065 carbon steel, fabricated and heat-treated
Hardness	Nuts: No. 4 thru #12 diameter: No standard applies 1/4" and larger: Rockwell HRC 32 maximum Washers: Rockwell C 44 - 48 Rockwell C 46 - 50 (when austempering process is used)
Plating	Nuts are usually supplied with a zinc or black oxide finish. See Appendix-A for more information.